

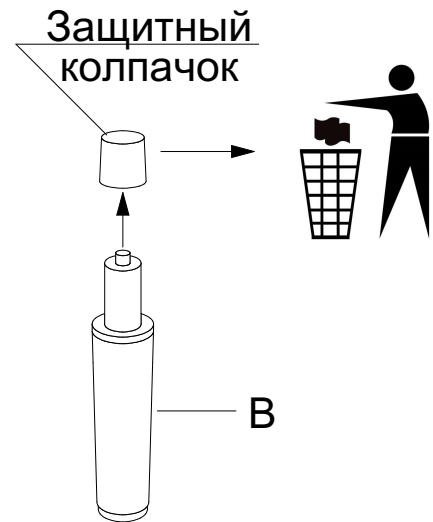

Внимание! Нарушение последовательности и условий сборки может привести к деформации опоры.

1



2

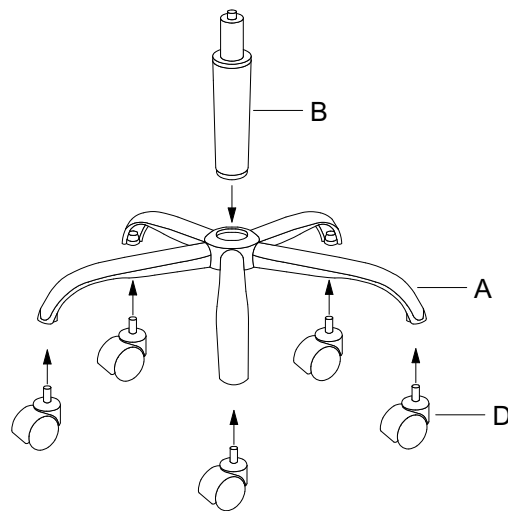

A

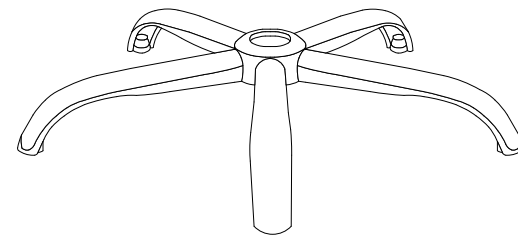

x1

B



x1

C

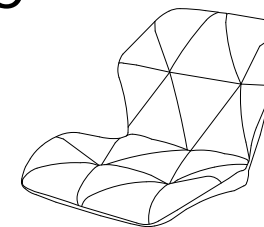

x1

3

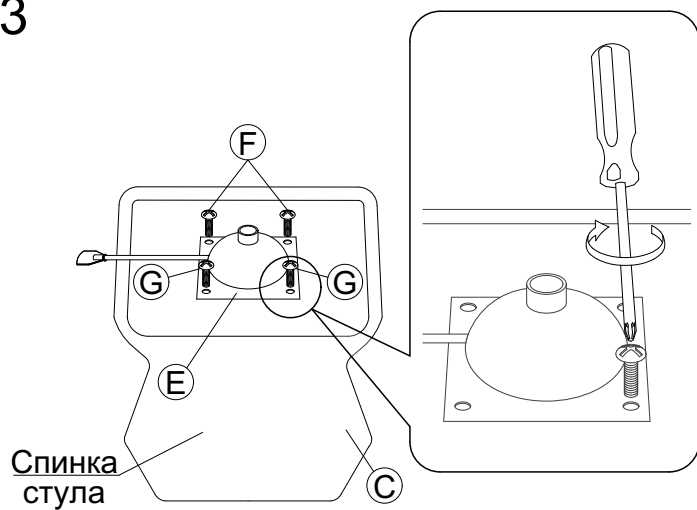

4

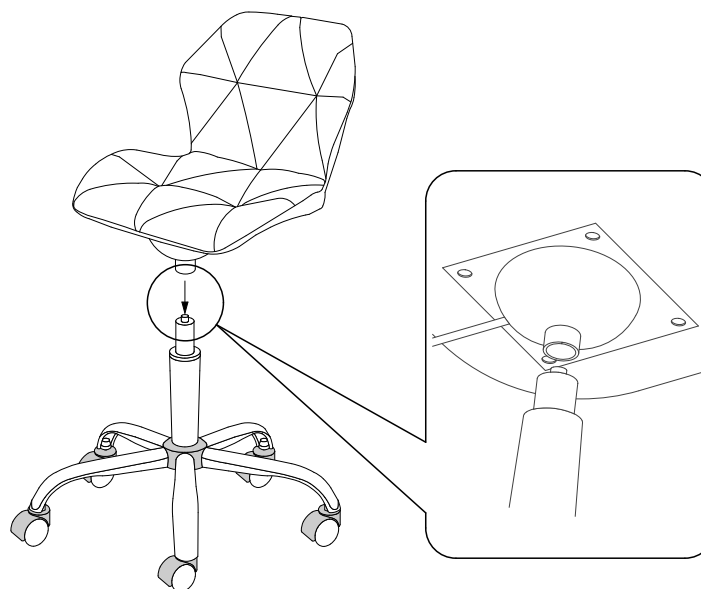

D

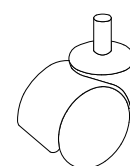

x5

E

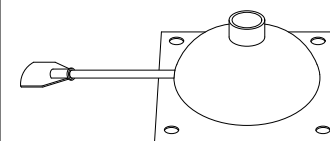

x1

F

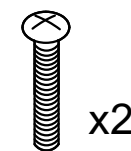

x2

Винт M6x30

G

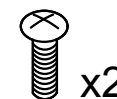

x2

Винт M6x16



Обратите внимание на размер и расположение болтов